

GEBERIT IN INDUSTRY

**KNOW
HOW**
INSTALLED



GEBERIT PIPING SYSTEMS SOLUTIONS FOR APPLICATIONS IN INDUSTRY



CHEMICAL AND PHARMACEUTICAL

Process, cooling and demineralised water
Compressed air
Industrial gases
Fire extinguishing systems



MECHANICAL ENGINEERING

Process, cooling and demineralised water
Compressed air
Industrial gases
Technical liquids
Fire extinguishing systems



FOODSTUFFS INDUSTRY

Drinking water pipes
Saturated steam
Industrial gases
Cleaning agents/disinfectants



SHIPBUILDING

Drinking water pipes
Heating/cooling
Engine room systems
Seawater pipelines
Fire extinguishing systems



AUTOMOTIVE INDUSTRY

Process, cooling and demineralised water
Compressed air
Industrial gases
Technical liquids
Oils and fuels

CONTENTS

GEBERIT SUPPLY SYSTEMS	4
GEBERIT DRAINAGE SYSTEMS	14
APPROVALS – ALWAYS ON THE SAFE SIDE	16
GEBERIT PRESSING SYSTEMS – THE BENEFITS AT A GLANCE	18
GEBERIT MAPRESS	20
GEBERIT TOOLS	30
GEBERIT MEPLA	32
GEBERIT PE	36
GEBERIT PLUVIA	38

GEBERIT SUPPLY SYSTEMS VERSATILE FOR TREATED WATER

Treated water is used in a variety of applications. Substances are removed or added depending on the intended purpose. The specific and precise change to the water quality is used, for example, in drinking water, filling water for cooling and heating systems or in service water in trade and industry. Geberit offers piping systems for virtually all treated water.

GEBERIT MAPRESS

The Geberit Mapress Stainless Steel pressing system is suitable for nearly all treated water, such as softened or fully desalinated water, as well as ultrapure water with conductivities of $\geq 0.1 \mu\text{S}/\text{cm}$. It ensures safe hygiene and corrosion resistance at pH values of ≥ 4 . As a rule, all methods for producing treated water, such as distillation, ion exchange or reverse osmosis, can be used.

GEBERIT MEPLA

The Geberit Mepla pressing system combines the advantages of plastic and metal pipes. Thanks to the multilayer pipes, pipe layouts can be adapted easily and flexibly to the constructional situation.

SMOOTH SYSTEM TRANSITIONS

Thanks to corresponding system components, making the transition from Geberit Mepla to Geberit Mapress Stainless Steel could not be simpler. It is now possible to make threaded adapters in PVDF within the Geberit Mepla piping systems, ensuring that water quality is reliably maintained.



↑
Geberit Mepla with plastic adapters

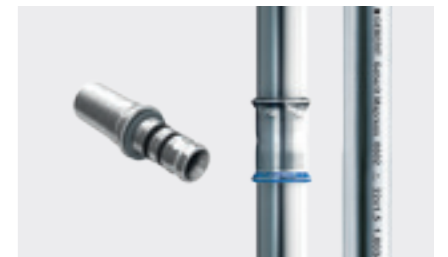

↑
Geberit Mapress Stainless Steel adapters

TREATED WATER FOR INDUSTRIAL APPLICATIONS (EXCEPT HEATING AND COOLING WATER)

	Geberit Mapress Stainless Steel 1.4401	Geberit Mapress Stainless Steel 1.4521	Geberit Mapress Copper CW 024 A ¹⁾	Geberit Mepla ¹⁾ (PERT II-AI-PE RT II)	
Softened water > 5 °dH	■	■	■	■	
Softened water < 5 °dH	■	■	■	■	
Demineralised water, level of purity 3	■	■	■	■	LF > 20 $\mu\text{S}/\text{cm}$
Demineralised water, level of purity 2	■	■			LF $\geq 1 \mu\text{S}/\text{cm}$
Demineralised water, level of purity 2+	■	■			LF > 0,1 $\mu\text{S}/\text{cm}$
Demineralised water, level of purity 1					LF > 0,05 $\mu\text{S}/\text{cm}$
Demineralised water, level of purity 1+					LF > 0,05 $\mu\text{S}/\text{cm}$

■ Applications with black CIIR seal ring for Geberit Mapress system and EPDM seal for Geberit Mepla with predetermined operating data

NOTE

Pressing systems are not suitable for water with increased requirements, such as ultrapure water type 1 or ultra-ultrapure water type 1+, or for water that is used to prepare medications (highly purified water) or for injection purposes (water for injection). Examples of increased requirements include LF < 0.1 $\mu\text{S}/\text{cm}$, CFU < 10/ml and TOC < 10 or seamless pipe joints.

¹⁾Copper, brass and gunmetal fittings are not suitable for demineralised water, level of purity < 3

GEBERIT SUPPLY SYSTEMS PRESSURE RESISTANT FOR COMPRESSED AIR PIPES

Whether compressed air is needed as control air in mechanical engineering or the automotive industry, or as process air for production or manufacturing processes, for instance, in the foodstuffs industry: the Geberit Mapress pressing systems offer the right pipe and fitting material for any required compressed air quality.



←
All systems are equipped with a pressing indicator and contour seal ring.

Compressed air is always an economical energy source when the procedures involved in generating, processing and distributing compressed air are optimally aligned with one another. Depending on the compressed air quality required, Geberit Mapress Stainless Steel, Carbon Steel or Copper can be used to distribute the compressed air. Geberit pressing systems have been used in compressed air systems

for many years. The permanently high tightness of the connection and the quick and simple installation technology mean that it is a high-quality and economical connection technology.

APPLICATION RANGES

Maximum operating pressures subject to pipe dimensions, details and higher pressures on request:

	Solids/particles class ¹⁾				Moisture/water class ¹⁾					Oil class ¹⁾		
	0	1-2	3-7	X	0	1-4	5-6	7-9	X	0-1	2-3	4-5
Geberit Mapress Stainless Steel 1.4401 (CrNiMo)	*	✓	✓	✓	✓	✓	✓	✓	✓	■	■	■
Geberit Mapress Carbon Steel, inside and outside zinc-plated 1.0215			✓	✓	✓	✓	✓				■	■
Geberit Mapress Carbon Steel, outside zinc-plated 1.0034			✓	✓	✓	✓					■	■
Geberit Mapress Carbon Steel, outside PP-jacketed 1.0034			✓	✓	✓	✓					■	■
Geberit Mapress Copper DIN EN 1057:2010-06	*	✓	✓	✓	✓	✓	✓	✓	✓	■	■	■

Geberit Mapress Stainless Steel and Geberit Mapress Carbon Steel:
16 bar for dimensions 12–54 mm, 12 bar for dimensions 76.1–108 mm

Geberit Mapress Copper:
12 bar for dimensions 12–54 mm

¹⁾ Purity class according to ISO 8573-1: 2010-04
* On request

■ Applications with black CIIR seal ring with predetermined operating data
■ Applications with blue FKM seal ring with predetermined operating data

GEBERIT SUPPLY SYSTEMS PROVEN SAFETY FOR INDUSTRIAL GASES

Geberit Mapress Stainless Steel and Mapress Stainless Steel (Gas) are tested and approved systems for a number of industrial gases and gas mixtures as well as fuel gases in accordance with DVGW data sheet G 260. These pressing systems offer a high-quality and economical alternative to welded, soldered or screwed piping systems. The positive-fit and lengthways non-positive connections are quick and easy to assemble and guarantee a high degree of tightness (leak rate of $< 1 \cdot 10^{-5}$).

GAS APPLICATIONS SAFELY UNDER CONTROL

Geberit Mapress Stainless Steel (Gas) and Copper (Gas) possess all the required approvals for fuel gases according to DVGW G 260. The fittings for gas installation have a yellow marking, as well as yellow protection plugs, making them easy to distinguish from other Geberit fittings straight away. To ensure secure sealing when transporting the volatile medium of gas, they are equipped with a yellow O-ring made of hydrogenated acrylonitrile-butadiene rubber (HNBR). The Geberit Mapress Stainless Steel (Gas) pressing system can be used for all natural and liquefied gas pipes in all dimensions from 15 to 108 mm.



↑ The Geberit Mapress Stainless Steel (Gas) pressing system can be used for all natural and liquefied gas pipes in all dimensions from 15 to 108 mm.



↑ Geberit fittings for gas applications are equipped with a yellow seal ring and yellow cap.

APPLICATION RANGES

	Acetylene	Argon	Natural gas	Helium	Carbon dioxide	Treated biogas	Propane	Oxygen	Nitrogen	Hydrogen	Shielding gases in accordance with DIN EN ISO 14175	Synthetic air
Geberit Mapress Stainless Steel 1.4401	■	■		■	■			■	■	■	■	■
Geberit Mapress Stainless Steel (Gas) 1.44011			■			■	■					
Geberit Mapress Copper ¹⁾ CW 024 A		■		■					■		■	■
Geberit Mapress Copper (Gas) ¹⁾ CW 024 A			■			■	■					
Temperature range (°C)	-10 to +50	-10 to +60	-20 to +70	-10 to +60	-10 to +60	-20 to +70	-20 to +70	-10 to +60	-10 to +60	-10 to +60	-10 to +60	-10 to +100

NOTE

Our works standard defines and guarantees high quality standards. All our system pipes and fittings are metallically bright, free of grease and oil, hygienically perfect and free of corrosive materials when delivered. The operating pressures listed in the TÜV component certificate are significantly limited by test reports, expert reports, standards and/or regulations in some cases depending on the medium (gas or combustible liquids, for example). Details available on request.

¹⁾ In connection with quality copper pipes in accordance with DIN EN 1057 and DVGW GW 392. Further gases and max. permissible operating pressures depending on gas type on request.

²⁾ Compressed air class 4, ISO 8573 and upwards.

- Applications with black CIIR seal ring with predetermined operating data
- Applications with yellow HNBR seal ring with predetermined operating data

GEBERIT SUPPLY SYSTEMS

SUITABLE FOR FUELS AND OILS

The Geberit Mapress Carbon Steel pressing systems are suitable and approved for heating oil and diesel, as well as engine, transmission and lubricating oil. The Geberit pressing systems are tried and tested and have been used in supply pipes for many years, particularly in the automotive industry and in vehicle and lorry repair shops.

APPLICATION RANGES

	Approval in acc. with VdTÜV		Approval in acc. with DIBt	
	Geberit Mapress Stainless Steel 1.4401	Geberit Mapress Carbon Steel 1.0034	Geberit Mapress Stainless Steel 1.4401	Geberit Mapress Carbon Steel 1.0034
Heating oil/diesel	■		■	■
Biodiesel	■		■	■
Petrol RON 95	■			
Petrol RON 98	■			
Kerosene	■			
Bioethanol	■ ■			
Methanol	■ ■			
Engine oils (SAE)	■		■	■
Transmission oils (SAE)	■		■	■
Waste oils (SAE)	■		■	■
Urea nitrate, e.g. AdBlue	■ ■		■	

Maximum permitted operating pressure in accordance with DIBt approval: 10 bar (for all dimensions).
Maximum operating pressures subject to pipe dimensions, details and higher pressures on request.

- Applications with black ClIR seal ring with predetermined operating data
- Applications with blue FKM seal ring with predetermined operating data

NOTE

The DIBt approval covers the use of Geberit Mapress for oils/fuels with a flashpoint > 55 °C. On the basis of the TÜV component certificate and in accordance with the requirements of the Pressure Equipment Directive (PED) and the relevant regulations, e.g. the German Federal Water Act (WHG) or the German Ordinance on Facilities for Handling Substances That Are Hazardous to Water (AwSV), the Geberit Mapress Stainless Steel pressing system can, if required, be used for flammable liquids with a flashpoint of < 55 °C. Use of the Geberit Mapress pressing systems for synthetic oils, brake fluids, cooling lubricants, penetrating oils and cutting oils must always be approved by Geberit.



GEBERIT SUPPLY SYSTEMS FUNCTIONALLY RELIABLE IN WATER COOLING SYSTEMS

Thanks to their levels of safety and reliability, water cooling systems are often used for machine, process and product cooling. Geberit supply systems guarantee safe and reliable supply at low and high temperatures by means of the cooling medium.

Water cooling systems, also known as water chillers, are generally self-contained circulation systems that produce cold by means of a liquid medium. In contrast to conventional refrigerating machines, water or water/glycol mixtures are used for cooling. What's more, the availability and absolute safety of the cooling medium are significant factors.



↑ Geberit Mapress Stainless Steel is the versatile piping system for technically demanding applications.



↑ The Geberit Mapress Carbon Steel system pipes and fittings are made of non-alloy steel 1.0034 and are available in a variety of designs.



↑ The Geberit Mepla multilayer piping system combines the advantages of metal and plastic.

APPLICATION RANGES

	Heating/cooling circuit closed to the atmosphere	Heating/cooling circuit open to the atmosphere	Temperature range (°C)	
Geberit Mapress Stainless Steel, product material 1.4401	✓	✓	-30 to +100	Limit value for chloride ion content, insulation in accordance with AGI (German Industrial Construction Association) worksheet A 132, otherwise corrosion protection coating.
Geberit Mapress Stainless Steel, product material 1.4521	✓	✓	-30 to +100	
Geberit Mapress Stainless Steel, product material 1.4301	✓	✓	-30 to +100	
Geberit Mapress Carbon Steel, outside zinc-plated 1.0034	✓		-30 to +100	Corrosion protection coating required in accordance with AGI (German Industrial Construction Association) worksheet Q 151.
Geberit Mapress Carbon Steel, PP-jacketed 1.0034	✓		-30 to +100	Fittings must be protected with overlapping corrosion protection sleeves on the pipe.
Geberit Mapress Copper, product material CW 024 A	✓	✓	-30 to +100	
Geberit Mepla (PERT II - AI - PERT II)	✓	✓	-10 to +70	

Applicable for water cooling systems with and without antifreeze agents (glycol-based frost protection).

In accordance with AGI (German Industrial Construction Association) worksheet Q 151, industrial systems made of non-alloy and low-alloy steels must be provided with additional corrosion protection for surface temperatures ranging from -50 °C to +150 °C. This is important for Mapress Carbon Steel, outside zinc-plated.

If increased chloride ion concentrations in conjunction with moisture and temperatures > 35 °C cannot be ruled out, stainless, austenitic steels should be protected against corrosion in accordance with the requirements of Q 151.

GEBERIT DRAINAGE SYSTEMS

RUGGEDNESS PERSONIFIED THE PROFESSIONALS FOR THE DIRTY WORK

Temperature changes, aggressive waste waters, pressure, shifts and chemical influences: the Geberit PE drainage system effortlessly withstands the loads in industrial and laboratory disposal or the loads on buried parts.

The Geberit PE drainage system provides safety and efficiency for use in industrial and laboratory drainage as well as for buried discharge pipes. The robust and shockproof piping material of high-density polyethylene (PE-HD) is resistant to abrasion, not affected by acids, lyes or other aggressive waste waters, as well as resistant to heat for hot water up to 80 °C, short-term up to 100 °C without simultaneous mechanical load, as well as resistant to cold down to -40 °C.

VARIED SOLUTIONS

The comprehensive assortment of fittings with special fittings and accessories makes Geberit PE the universal solution for numerous drainage tasks. It is suitable, among other things, for use in industry, trade, laboratories, for buried underground pipes and for roof drainage with Geberit Pluvia.



↑ Lengthways non-positive connections by means of butt and electrofusion welding



↑ Removable connections with loose flange or screw connection

APPLICATION RANGES WITH GEBERIT PE

		Share (%)	Room temperature (20 °C)	Increased temperature (60 °C)
Alkalis	Caustic potash	Up to 50	✓	✓
	Caustic soda	All	✓	✓
Acids	Sulphuric acid*	Up to 70	✓	✓
	Hydrochloric acid*	Up to 28	✓	✓
	Nitric acid	Up to 25	✓	✓
	Phosphoric acid	Up to 50	✓	✓
Salts	Calcium chloride	All	✓	✓
	Sodium chloride (salt)	All	✓	✓

* The connections are to be produced lengthways non-positive by means of butt or electrofusion welding. Use with seals only on request from Geberit.

APPROVALS ALWAYS ON THE SAFE SIDE

Geberit supply and drainage systems have a number of approvals for applications in technical building systems and in industry. Because of this, our customers are on the safe side of the law when it comes to their projects, and they can count on reliable and tested functions.



↑
SHIPBUILDING

Various Geberit Mapress systems for shipbuilding applications have approvals from a number of classification societies, including Bureau Veritas, the American Bureau of Shipping (ABS), Registro Italiano Navale (RINA), the Russian Maritime Register of Shipping, Det Norske Veritas and Germanischer Lloyd (DNV GL), China Classification Society (CCS) and Lloyd's Register.



↑
TECHNICAL BUILDING SYSTEMS

In the area of technical building systems, Geberit has approvals and certifications from a number of bodies, including the German Technical and Scientific Association for Gas and Water (DVGW), the Swiss association of gas and water (SVGW), the British Water Regulations Advisory Scheme (WRAS), the Austrian Association for Gas and Water (ÖVGW), the French Scientific and Technical Center for Building (CSTB) and KIWA.



↑
INDUSTRY

For industrial applications, Geberit Mapress has approvals from several bodies, including the German Association of Technical Inspection Agencies (Vd TÜV), the German institute for building technology (DIBt), the German institute for material research and testing (BAM), VdS Schadenverhütung (loss prevention), FM Approvals and the Global Loss Prevention Certification Board (LPCB).



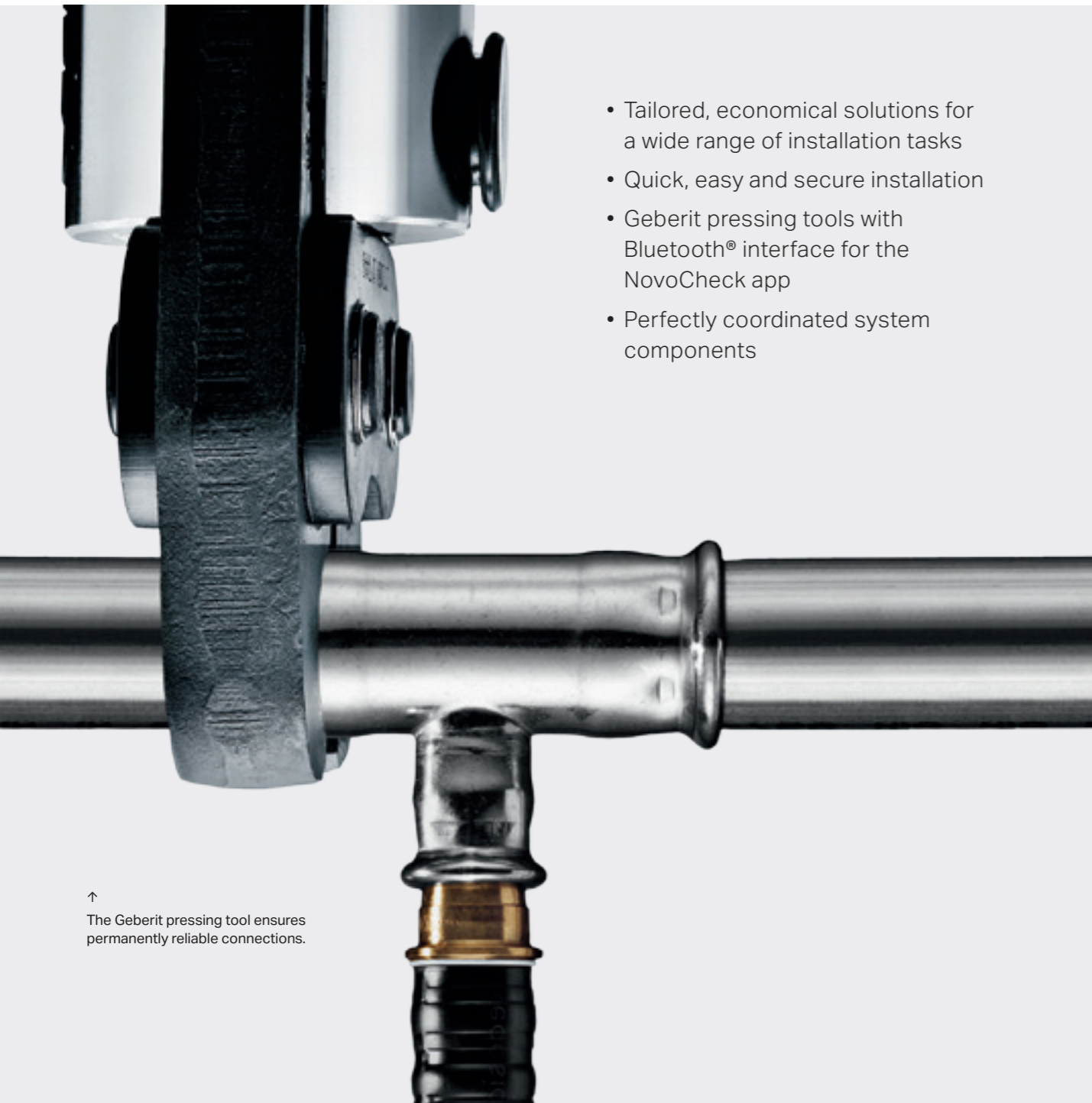

- Tailored, economical solutions for a wide range of installation tasks
- Quick, easy and secure installation
- Geberit pressing tools with Bluetooth® interface for the NovoCheck app
- Perfectly coordinated system components

↑
The Geberit pressing tool ensures permanently reliable connections.



↑
Mechanically stable and hydraulically leakproof: the press connection.



↑
Leaky if unpressed.

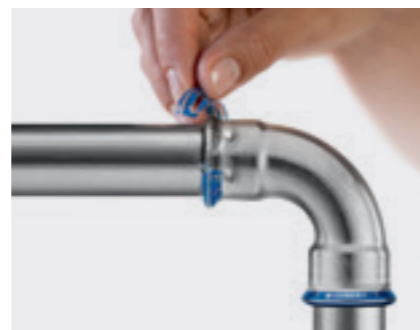

↑
Coloured indicators identify unpressed Mাপress fittings even before the pressure test.

GEBERIT PRESSING SYSTEMS

QUICKLY AND RELIABLY CONNECTED

Your customers expect reliable and durable pipe joints. They value quick and economical work on the building site. The Geberit supply systems, which have been used successfully for decades, enable you to achieve both goals.

SPEED MEANS COST-EFFECTIVENESS

The pipe and/or fitting change shape when they are pressed with a pressing tool developed for this purpose. Geberit press connections create solid mechanical connections which are permanent and lengthways non-positive. The resilience of the deformed seal rings ensures that the fittings are permanently and hydraulically leakproof. Pressing is a quick connection method which saves a lot of time in comparison to traditional methods such as soldering or welding. As open flames are not required, many time-consuming protection measures can also be dispensed with.

IT'S VISIBLY SECURE

Geberit supply systems have different mechanisms for ensuring correct processing.

Correct insertion depth

With the Geberit Mepla system, the pipe is inserted until it reaches a stop position on the fitting. It is easy to see the correct connection.

Tool guide rim

In all pressing systems, the pressing jaws are designed in such a way that it is almost impossible to position the tool incorrectly. This reduces or prevents failed pressing sequences.

Pressing indicator

Unpressed Geberit Mাপress fittings are identified by the coloured, intact pressing indicators. The coloured pressing indicators at the ends of the fittings are easy to remove after the pressing procedure.

Leaky if unpressed

Geberit Mepla and Geberit Mাপress¹⁾ fittings are "leaky if unpressed" when subjected to pressure tests with water or air. Defined leak paths ensure that connections which have not yet been pressed are detected reliably. You and your customer can therefore be assured that no nasty surprises will suddenly jump out at you later on and that everything will stay reliably leakproof.

¹⁾ Only applies to black CIRR seal rings typically used in technical building systems.

GEBERIT MAPRESS

FOUR PRODUCT MATERIALS

FOR ALL MANNER OF INDUSTRIAL REQUIREMENTS



For the last 50 years, the name Mapress has stood for a technologically advanced piping system with economically superior and more intelligent connection technology. Geberit Mapress has already paved the way for generations of plumbers who are now abandoning complex connection technologies in favour of simple and reliable pressing. With the wide range of robust product materials, the comprehensive product range, as well as the numerous combination options, Geberit Mapress sets itself apart from the rest due to its universality and is now indispensable in the day-to-day activities of the sanitary industry.

THE GROUNDBREAKING SYSTEM

Geberit Mapress is available in stainless steel, carbon steel or copper. Thanks to the large spectrum of pipe dimensions, fittings in different product materials and with different seal rings, Geberit is able to provide solutions for virtually any application in technical building systems and industry. Geberit Mapress CuNiFe is also available for use in shipbuilding projects.

EASY CONNECTION

Making the connection couldn't be easier: the whole deburred pipe is inserted into the fitting. The pressing jaw with the groove is close-coupled on the predetermined pressing contour and the pressing procedure is performed with permanent pressing. The pin marking is useful for checking the insertion depth retroactively. The risk of an error during the pressing operation is virtually zero.

PROTECTION AGAINST DUST AND DIRT

The pressing sockets of the metal fittings are fitted with protection plugs which offer protection against dust and dirt on the building site and therefore ensure hygienically clean installations from the start. The protection plugs are transparent for general applications and yellow for gas application fittings.



←
CIIR, BLACK
General applications in technical building systems and industry.



←
FKM, BLUE
High temperature and chemical resistance.



←
HBNR, YELLOW
The specialist for gas applications.



←
FKM, WHITE
The expert for saturated steam applications.

- Geberit pressing technology for reliable leakproof connections
- Multiple national and international approvals

- For high requirements in terms of hygiene and load bearing capacity
- Can be chemically and thermally disinfected
- Extremely high corrosion resistance and excellent hygiene characteristics
- Suitable for different – even aggressive – media



GEBERIT MAPRESS STAINLESS STEEL 1.4401

GLOSSY FINISH FOR HIGH REQUIREMENTS

Geberit Mapress Stainless Steel is the versatile installation system which meets high technical requirements. The product material demonstrates its performance capability in the drinking water supply, in complex industrial applications and in installations with high hygienic requirements, such as those in hospitals or laboratories.

System pipes made of high-alloy, austenitic, stainless CrNiMo steel with material number 1.4401 according to DIN EN 10088, available in pipe dimensions of 12–108 mm.

HIGH MOLYBDENUM CONTENT

The Geberit Mapress Stainless Steel 1.4401 system has a minimum molybdenum content of 2.2%. This value is higher than the usual standards and therefore ensures an extremely high corrosion resistance.

HYGIENICALLY PURE ALL THE TIME

Geberit Mapress Stainless Steel system pipes and fittings are delivered to wholesalers from the factory free of grease and oil and hygienically perfect, sealed with plugs and caps. If required, Geberit Mapress Stainless Steel can be used for chemical and thermal disinfection in accordance with the Drinking Water Ordinance and DVGW data sheet W 557.

APPROVED

Geberit has a number of approvals for Mapress Stainless Steel in technical building system installations and industrial and shipbuilding applications. For example, Geberit Mapress Stainless Steel is approved for drinking water installations, certified by DVGW with the system approval mark DW-8501AT2552, for sprinkler systems, certified by VdS G 4990013 and G 4910039, and for fluids in Groups 1 and 2 in accordance with the Pressure Equipment Directive (PED) 2014/68/EU, certified by TÜV component certificate TÜV A.271-17.

A COMPREHENSIVE SYSTEM

With eleven nominal widths and around 500 fittings and adapters, Geberit Mapress Stainless Steel offers a comprehensive range of application options. The Geberit Mapress Stainless Steel fittings are identified by the blue indicator ring.



↑

Geberit Mapress is approved for sprinkler systems.

- For closed circuits, compressed air systems as well as “wet” sprinkler and extinguishing water pipes
- Easy and safe processing



GEBERIT MAPRESS CARBON STEEL

CLOSED CIRCUITS

RELIABLY PRESSED

Geberit Mapress Carbon Steel is an economical solution for piping systems that are closed to the atmosphere. Typical application ranges include heating and cooling circuits, solar systems and “wet” sprinkler and extinguishing water pipes.

JACKETED OR ZINC-PLATED

The Geberit Mapress Carbon Steel pressing system comprises system pipes and fittings, outside zinc-plated with material number 1.0034, as well as system pipes, plastic jacketed (PP) with material number 1.0034, and system pipes, inside and outside zinc-plated with material number 1.0215. Geberit Mapress Carbon Steel is available in pipe dimensions of 12–108 mm; the plastic-jacketed system pipes are available in dimensions of 12–54 mm.

BROAD RANGE OF APPLICATIONS

With its 8 µm thick zinc layer, Geberit Mapress Carbon Steel, outside zinc-plated, meets the requirements of stress stage 1 in accordance with DIN EN ISO 2081. Geberit Mapress Carbon Steel is therefore suitable for laying in dry, heatable interiors (corrosivity category C1). The plastic-jacketed system pipe with cream polypropylene jacketing is particularly suitable for visually unobtrusive surface mounting, as well as cooling circuits closed to the atmosphere. The inside and outside zinc-plated system pipe is the economical alternative for “wet” sprinkler and extinguishing water pipes and compressed air installations.

BEST CONNECTIONS TO MEPLA AND PUSHFIT

Over 400 fittings are available for a diverse range of application solutions. Suitable adapters ensure quick, easy and reliable connections to Geberit Mepla or Geberit PushFit, for an economical connection to heating radiators, for example.

Always the right pipe: Geberit Mapress Carbon Steel pipes are offered with PP jacketing, outside zinc-plating or inside and outside zinc-plating.

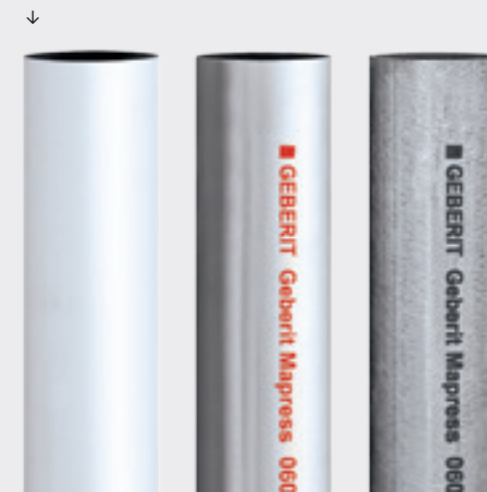

GEBERIT MAPRESS COPPER

ROBUST CLASSIC WITHOUT SOLDERING

Robust, convenient and hygienic: this is why many plumbers regularly use copper. With Geberit Mapress fittings, you benefit from the contemporary connection technology, which is processed reliably without soldering and therefore without fire risk.

The Geberit Mapress selection of copper products includes fittings from DHP copper with material number CW024A, gunmetal with material number CC449K and brass with material numbers CW602N and CW617N.

VERSATILE APPLICATIONS

In drinking water installations, heating and cooling water systems, as well as gas and compressed air pipes – copper is found on many building sites even today. Geberit Mapress Copper is also suitable for special applications with increased requirements.

SAFE PROCESSING WITHOUT AN OPEN FLAME

Pressing rather than soldering – Geberit Mapress Copper is also based on this principle. This increases safety on the building site, as an open flame is not used. Complex fire protection measures are therefore not required.

COMPREHENSIVE FITTING ASSORTMENT

The Geberit Mapress copper range comprises a variety of fittings in dimensions of 12–108 mm for Mapress Copper and dimensions of 12–54 mm for Mapress Copper (Gas). Geberit recommends using quality copper pipes in accordance with DIN EN 1057 and DVGW GW 392 – annealed (R220), half-hard (R250) or hard (R290) depending on the dimension.

- Pressed quickly without an open flame
- Robust connection through cold deformation of pipe and fitting
- Safety thanks to clear detection of unpressed connections
- High pressure and temperature resistance



←
Geberit Mapress Copper fittings for a multitude of application ranges.

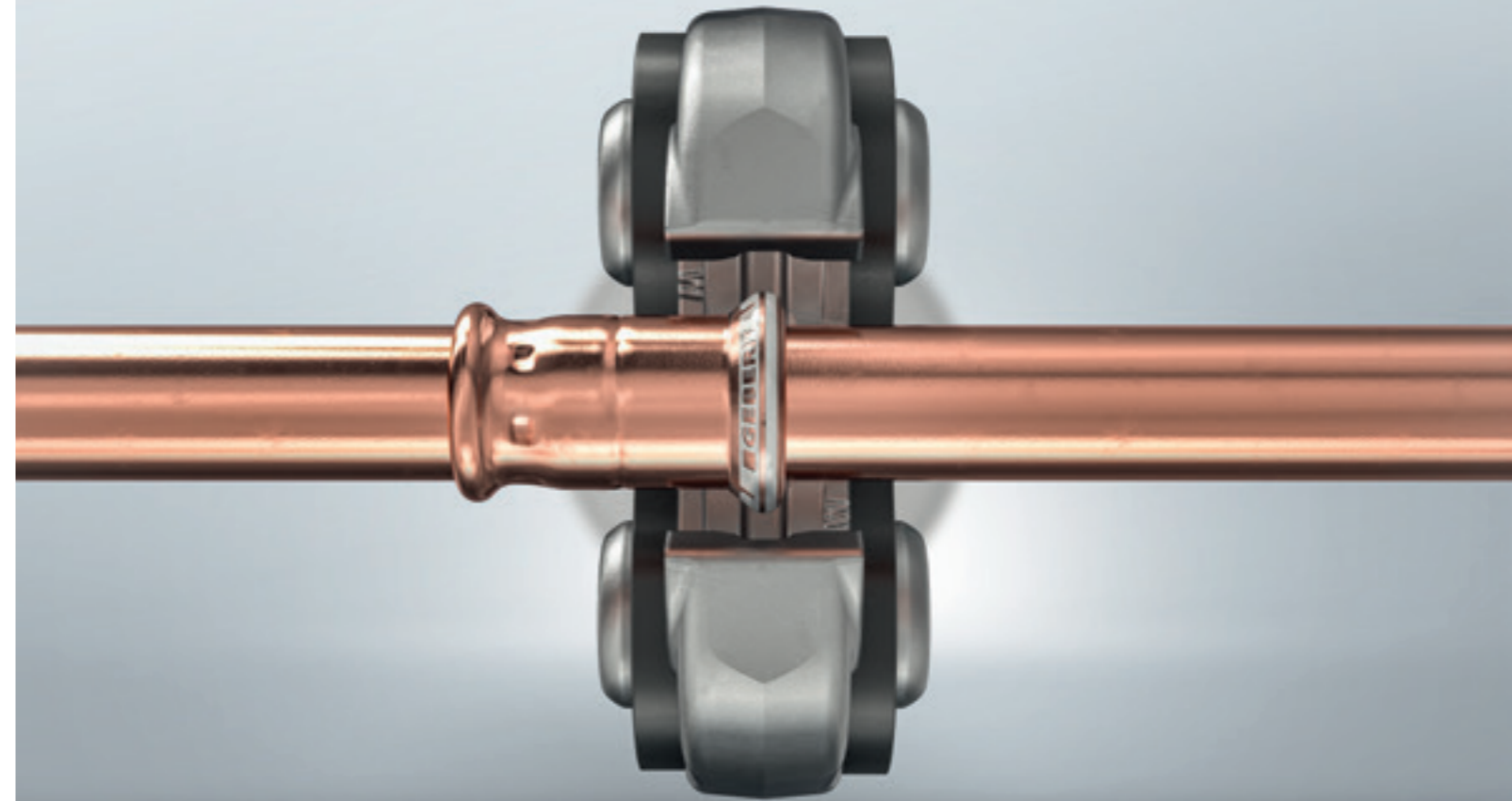

GEBERIT MAPRESS CUNIFE

WHEN YOUR WATER IS SEAWATER

Seawater has a corrosive effect on many metals due to its chloride content. Geberit Mapress CuNiFe system pipes and fittings are THE specialists for applications involving contact with seawater, and are therefore fit for use in a range of shipbuilding and offshore projects.

Geberit Mapress CuNiFe system pipes and fittings consist of a CuNi10Fe1.6Mn alloy with material number CW325H.

PROVEN EFFECTIVENESS IN CONTACT WITH SEAWATER

Geberit Mapress system pipes and fittings made of CuNiFe have an excellent corrosion resistance to seawater. This high corrosion resistance is due to a natural, thin protective coating that quickly forms upon contact with clean seawater. This complex protective coating is mainly made up of copper oxide and is improved by additional nickel and iron, ensuring excellent corrosion resistance.

WIDE RANGE OF APPLICATIONS

The reliability and corrosion resistance of the Geberit Mapress CuNiFe system pipes and fittings have proven themselves in a variety of applications in which installations carry seawater. Shipyards, shipping companies and system suppliers put their trust in this system, using it in shipbuilding and offshore projects for machine systems, fire extinguishing systems and sanitary technology systems. A further area of application is in seawater desalination plants.

RELIABLE PROCESSING WITHOUT NEW TOOLS

Geberit Mapress CuNiFe is suitable for piping systems up to pressures of 16 bar. The tried-and-tested Geberit pressing tools are also used for Geberit Mapress CuNiFe, guaranteeing the mechanical strength and tightness of the connections. As is standard practice at Geberit, Geberit Mapress CuNiFe system pipes and fittings are delivered with protective plugs to protect them from impurities and maintain installation hygiene right up to the processing stage. The system pipes are available in dimensions of 12–108 mm.



→
Geberit Mapress CuNiFe fittings are easily identifiable thanks to their colour and black indicator ring.

- Excellent corrosion resistance to seawater
- Black protective caps on the pipe ends and protective caps on the fittings prevent the accumulation of dust and dirt
- Special thermal and mechanical treatments of the pipes and fittings create a homogeneous, high-quality material structure



GEBERIT TOOLS FOR PRESSING SYSTEMS

STRONG FOR RELIABLE PRESSING OPERATIONS



Low weight, faster work and convenience: this is what the Geberit pressing tools have to offer. Alongside the Geberit pressing collars with snap mechanism and the maintenance-free Geberit pressing jaws, Geberit tools ensure quick processing and a reliable connection when installing supply systems.

CONVENIENT PROCESSING

The Geberit pressing tools are compact, light-weight and provide a high level of convenience. Their easy handling and low weight are particularly noticeable when performing overhead work.

EFFECTIVE WORK

The battery-operated Geberit pressing tools are fitted with modern lithium-ion batteries. Thanks to the long battery running time, the Geberit pressing tools require charging less often and, due to short charging times, they can be put back into operation more quickly.

DIGITALLY CONNECTED

The Geberit pressing tools ACO 103plus, ACO 203plus and ACO 203XLplus each have a Bluetooth® interface for the NovoCheck app, which can be used to read out device information and pressing documentation.

NO MAINTENANCE THROUGHOUT THE ENTIRE SERVICE LIFE

High pressing performance without the need for external maintenance: the maintenance-free Geberit pressing jaws ensure a balanced distribution of force which lasts throughout the entire service life.

FOR LARGE DIMENSIONS

Regardless of how the pipes are aligned, these are held firmly onto the pressfitting by a snap mechanism in the Geberit pressing collars, thereby ensuring easy and reliable handling.



↑ An integrated pressing point light in the Geberit ACO 203plus, ECO 203 and ACO 203XLplus ensures good visibility in dark corners.



↑ The Geberit PowerTest provides you with information about the condition of your Geberit pressing jaw.



↑ Pressing collars are used from a diameter of 63 mm in Geberit Mepla and a diameter of 42 mm in Geberit Mapress.

- Flexible, bendable and yet inherently stable
- Clean, safe and easy to process
- Reliable press connection
- Quick and secure transitions to other systems such as Geberit Mapress and Geberit PushFit



GEBERIT MEPLA

FLEXIBLE AND INHERENTLY STABLE

The Geberit Mepla multilayer pipe system combines the advantages of metal and plastic. Ensuring fast progress at the building site and complying with all the necessary standards and regulations.

THREE LAYERS FOR DRINKING WATER AND HEATING

Lighter than metal pipes, more inherently stable and robust than plastic pipes, and easy and safe to process: Geberit Mepla combines the advantages of both types of pipe. Stable, bendable and able to form a barrier against diffusion: Geberit Mepla also remains leakproof when subjected to pressure far in excess of the standard testing pressure of 1.1 MPa (11 bar). The outer plastic layer made of polyethylene (PE-RT of the second generation) protects against corrosion and mechanical damage. The central aluminium layer makes the pipe stable and bendable. The inner layer, which is likewise made of PE-RT, is corrosion-resistant and food-safe. In accordance with the Drinking Water Ordinance, Geberit Mepla is suitable for all types of drinking water without restriction.

SAFE INSTALLATION OF DRINKING WATER AND HEATING

With Geberit Mepla, you only need one single system for the drinking water and heating supply. Pipe dimensions from 16 to 75 mm and a selection of around 300 fittings made of polyvinylidene fluoride (PVDF) and gunmetal offer a

solution for almost any installation task. All pipe dimensions are permitted for use in the heating installation from 0 to 80 °C, in the drinking water installation from 0 to 70 °C and for operating pressures up to 1 MPa (10 bar). Clever connections such as the cross fitting have proven their worth in day-to-day applications such as radiator connections for a connection to two parallel pipes without intersecting.

THE ECONOMICAL SYSTEM

Geberit MasterFix establishes quick connections to the Geberit sanitary elements. Special fittings simplify the transitions of Geberit Mepla to the metal Geberit Mapress system or the Geberit PushFit fitting system. Installing series-connected or circular pipes is especially economical with the Geberit MasterFix T-piece.

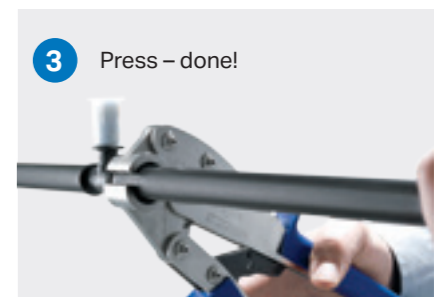
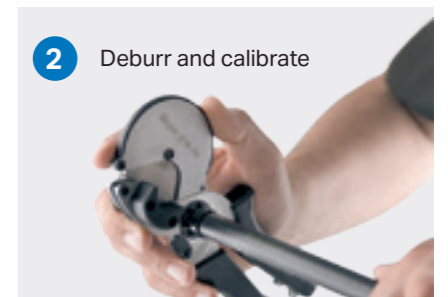
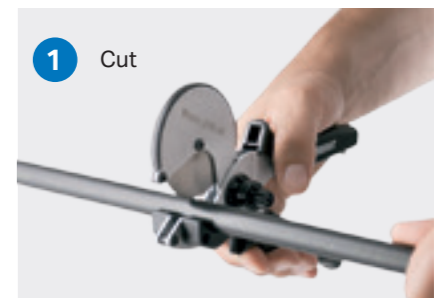

GEBERIT MEPLA

LEAKY IF UNPRESSED

Unpressed fittings can be reliably identified during a leak test.

HIGH STABILITY

Using polyethylene and aluminium combines the benefits of plastic with those of metallic systems.

HYGIENICALLY PERFECT

The surface roughness of just 7 µm reduces the build-up of chalk and biofilm. Protective caps ensure reliable and hygienic protection during storage and transport.

PRESSING JAW GUIDE

The defined pressing jaw guide prevents slipping and failed pressing sequences.

RELIABLE INSPECTION OF THE INSERTION DEPTH

The insertion depth remains visible at all times and indicates whether the pipe has been correctly pushed onto the fitting.

IDEAL FOR COLD-WATER PIPES

Special processing is not required for corrosion protection.

SAFE FOR HIGH LOADS

The high tensile strength of the Geberit Mepla connections ensures reliable functioning even with high loads.

FORMS A BARRIER AGAINST DIFFUSION

The aluminium layer reliably prevents oxygen diffusion – ideal, for example, for heating applications.

LARGE DIAMETER

Available up to a dimension of 75 mm.

EASY AND RELIABLE INSTALLATION

The uniform bending capacity enables flexible adjustment to on-site conditions, and the cams and retaining rings ensure reliable installation, alignment and pressing operations. There are also fewer fastening points than with other plastic pipes.

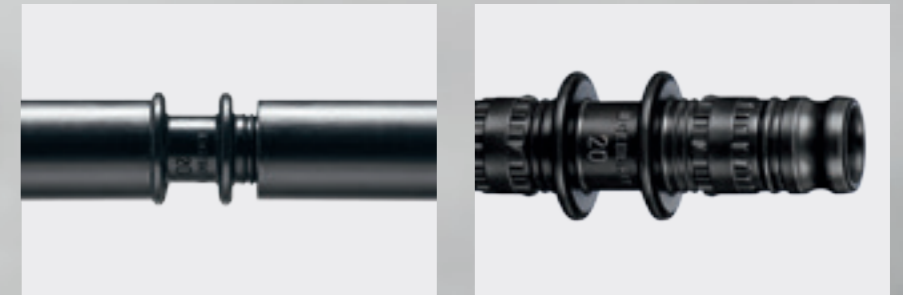
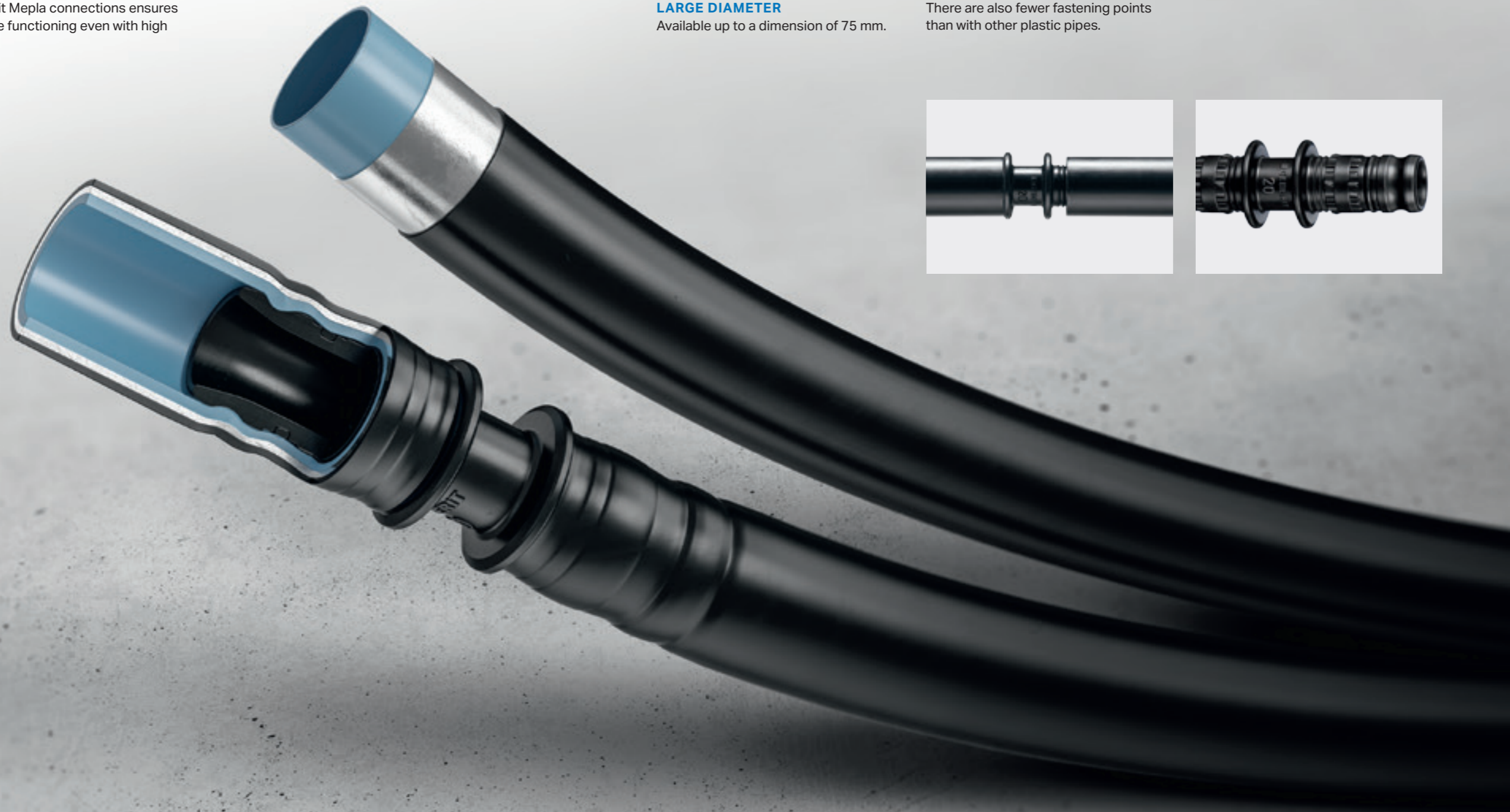

GEBERIT PE

ROBUST RESISTANCE NO MATTER WHAT

- Large range of products and wide range of dimensions
- High temperature and chemical resistance
- Robust and shockproof
- Various connection options
- Environmentally friendly plastic

Massive temperature changes, aggressive waste waters and soils, pressure, shifts and chemical influences: when high resistance is required in drainage technology, Geberit PE is the ideal system, fulfilling all the relevant standards.

DEFIES EXTREME TEMPERATURES

The high density of the material makes Geberit PE particularly robust. Hot water does not affect the material at temperatures of up to 80 °C – or even up to 100 °C in the short term and under certain conditions. In the event of cold, the tough material is even still shockproof at temperatures of -40 °C.

SHOCKPROOF AND FLEXIBLE

The pipes and fittings withstand shocks, drops, impacts or pressures of up to 1.5 bar without breakage or permanent deformation. This robustness provides, most notably, a guarantee during the construction stage that the pipeline will remain intact despite possible mechanical influences.

RESISTANT TO CHEMICALS

The Geberit PE drainage system is suitable for a multitude of applications in industry or laboratories. The material is resistant to most standard alkalis, acids and chemicals.

PERMANENT SEAL

The welding joints of Geberit PE pipes remain persistently leakproof for many years and offer building owners and plumbers a high degree of safety.

COMPREHENSIVE ASSORTMENT

The robust pipes are available in all common diameters from 32 to 315 mm, and the range of fittings including the special fittings is nearly comprehensive.



↑
PERFECTLY EQUIPPED FOR NEARLY ALL TASKS
Geberit PE has a very wide assortment

GEBERIT PLUVIA

ROOF DRAINAGE WITH NEGATIVE PRESSURE

- High savings in materials
- Fast installation
- Optimal design freedom and use of space
- Less time spent on maintenance
- High performance and reliability

Geberit Pluvia drains roofs efficiently and reliably even under the heaviest rainfall. Because significantly less product material and space is required for syphonic roof drainage than for conventional systems, free space is opened up. More design freedom in planning, higher profitability during installation and in operation: good reasons to opt for Geberit competence. Through tried-and-tested technology, innovative details and comprehensive service, Geberit Pluvia has been setting new standards for many years.

While conventional systems simply allow rain to run off through sloping pipes, the compact Geberit Pluvia pipe system fills up quickly and extracts the rainwater from the roof using the resultant negative pressure. The Geberit Pluvia roof outlets prevent air from being sucked in and guarantee reliable performance.

The result: double the amount of rainwater discharge at half the pipe diameter. There is also greater design freedom in terms of planning, since there is no longer any need for pipelines that have to be laid with a slope.

SUITABLE FOR PRACTICALLY ANY ROOF SHAPE

Geberit Pluvia ensures architectonic freedom, as different roof shapes can be reliably drained with it. The syphonic roof drainage makes many things possible that would not be technically feasible with conventional systems.

FEWER ROOF OUTLETS

Thanks to the high discharge rate of the syphonic roof drainage system, fewer roof outlets are required. This results in savings in product material and the amount of work needed, while also preserving the roof.

FEWER DISCHARGE STACKS

Because the pipes are filled completely, fewer drains are required. The effect: more flexibility in planning.

FEWER UNDERGROUND PIPE CONNECTIONS

Fewer discharge stacks and fewer connections mean lower installation and material costs.

SMALLER PIPE DIAMETERS

Geberit Pluvia pipelines are designed for a complete filling. This reduces the pipe diameter to a minimum.

SELF-CLEANING SYSTEM

The high flow velocity when the pipeline is filled produces suction which contributes to the self-cleaning of the system. This ultimately means less time spent on maintenance.

NO SLOPE

Because Geberit Pluvia pipelines are laid horizontally, the drainage system does not result in any loss of space.

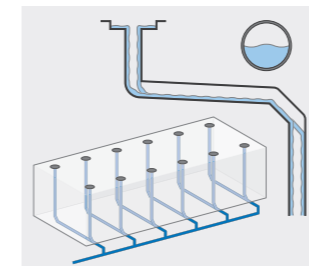

↑
Conventional roof drainage system

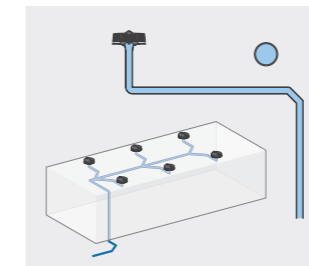

↑
Geberit Pluvia syphonic roof drainage

Geberit B.V.
Fultonbaan 15
3439 NE Nieuwegein
Postbus 668
3430 AR Nieuwegein

T 030 - 605 77 00
F 030 - 605 33 92
info.nl@geberit.com

www.geberit.nl